

 **Shed Windows and More** ®

2016





## **Shed Windows and More** ®

Shed Windows and More, Inc. is not just a company, we are a family business! Since 2003, Shed Windows and More Inc. has had everything you need to complete your project. What sets us apart is our high quality, great selection and the best customer service, which is why Shed Windows and More Inc. is here today. From the full time builder to the weekend do it yourself or attempting your first project, Shed Windows and More Inc. will help to provide you with the products you need to complete that project.

 **Shed Windows and More** ®

2016

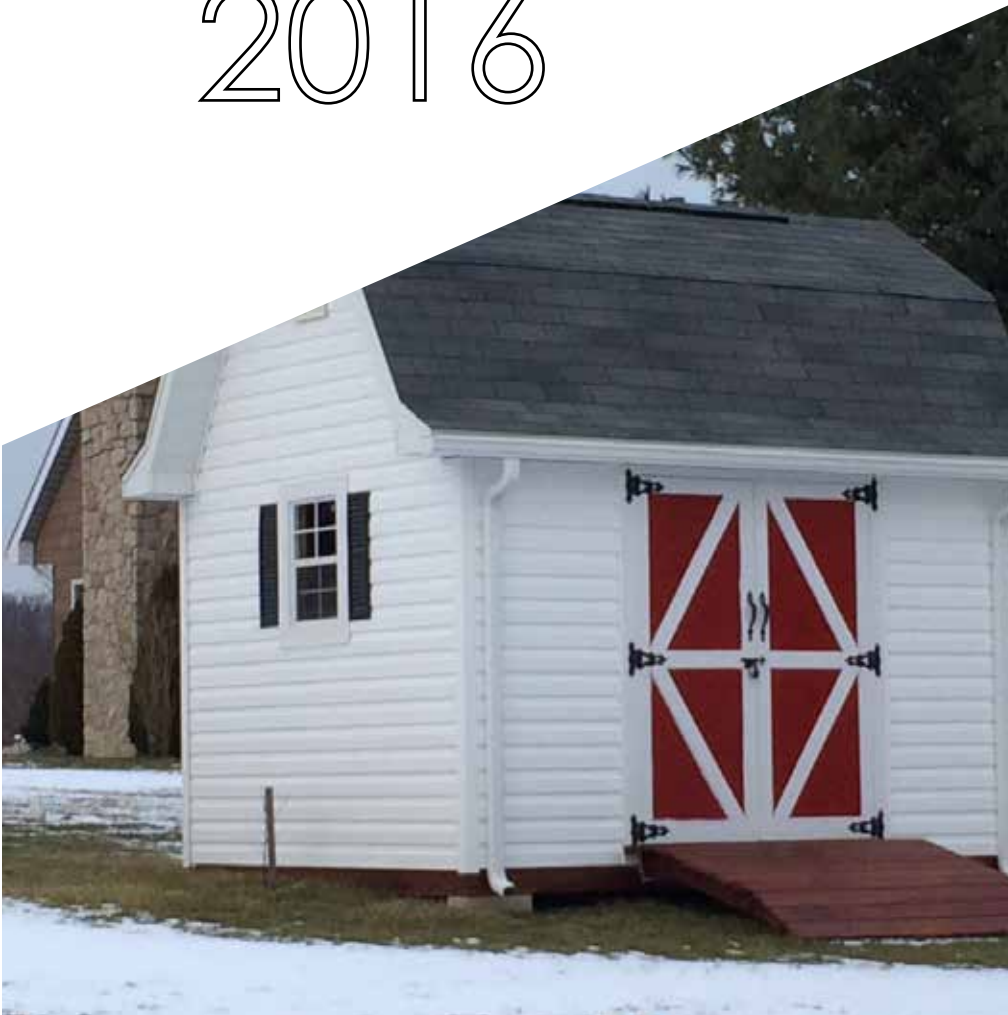

## CONTENT

Verticle Sliders

Arched Windows

MoreView

DurraView

Decorative Gable Windows

Transoms

Handles

Door Hardware

Hinges

Hardware Kits

Screws & Vents

Skylights

Miscellaneous Products

 **Shed Windows and More** ®

Office Manager: Theresa Slack

Email: [theresa@shedwindowsandmore.com](mailto:theresa@shedwindowsandmore.com)

Sales: James Slack

Email: [James@shedwindowsandmore.com](mailto:James@shedwindowsandmore.com)

Sales: Thomas Slack

Email: [Thomas@shedwindowsandmore.com](mailto:Thomas@shedwindowsandmore.com)

Phone: (843) 293-1820 Fax: (843) 293-1826

Website: [shedwindowsandmore.com](http://shedwindowsandmore.com)

# Vertical Sliders

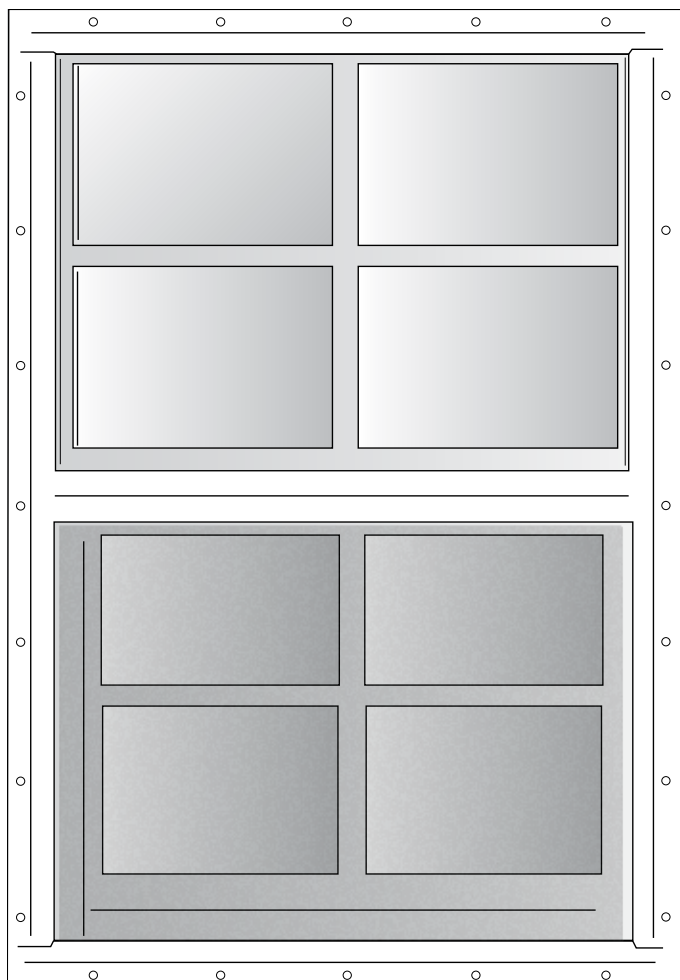

## Vertical Sliders - Stats

- All windows now come standard with 4.7625 mils (3/16") safety/tempered glass
- We have increased the thickness of the aluminum in the frame for added strength
- Notched inner frame to allow for multiple open locking positions, screen included
- Spring loaded latches allow windows to lock in open positions
- There is a 1" screw flange all around the window, the depth of the window is 1-1/2"
- J-Channel is 7/8" and is only available in white
- J-Channel 7/8" is used for vinyl or metal siding. It is also used to slide in trim board. The glass of the window will be flush with the product you insert into the J-Channel
- Weather stripping on sash for weather resistance
- Sloped sill for drainage
- Nylon glides make for an easy open and close operation
- Easy installation

## 12x18 Playhouse/Chicken Coop

SKU	Overall Size	Rough Opening	Color	Mount
1218WF	13"-1/2" x 19-1/2"	12-1/4" x 18-1/4"	White	Flush
1218WJ	14"-1/2" x 20-1/2"	12-1/4" x 18-1/4"	White	J-Channel
1218BF	13"-1/2" x 19-1/2"	12-1/4" x 18-1/4"	Brown	Flush

## 14x21 Playhouse/Chicken Coop

SKU	Overall Size	Rough Opening	Color	Mount
1421WF	15"-1/2" x 22-1/2"	14-1/4" x 21-1/4"	White	Flush
1421WJ	16"-1/2" x 23-1/2"	14-1/4" x 21-1/4"	White	J-Channel
1421BF	15"-1/2" x 22-1/2"	14-1/4" x 21-1/4"	Brown	Flush

## 14x27 Playhouse/Chicken Coop

SKU	Overall Size	Rough Opening	Color	Mount
1427WF	15"-1/2" x 28-1/2"	14-1/4" x 27-1/4"	White	Flush
1427WJ	16"-1/2" x 29-1/2"	14-1/4" x 27-1/4"	White	J-Channel
1427BF	15"-1/2" x 28-1/2"	14-1/4" x 27-1/4"	Brown	Flush

# Vertical Sliders

## 18x23 Vertical Slider

SKU	Overall Size	Rough Opening	Color	Mount
1823WF	19"-1/2" x 24-1/2"	18-1/4" x 23-1/4"	White	Flush
1823WJ	20"-1/2" x 25-1/2"	18-1/4" x 23-1/4"	White	J-Channel
1823BF	19"-1/2" x 24-1/2"	18-1/4" x 23-1/4"	Brown	Flush

## 18x27 Vertical Slider

SKU	Overall Size	Rough Opening	Color	Mount
1827WF	19"-1/2" x 28-1/2"	18-1/4" x 27-1/4"	White	Flush
1827WJ	20"-1/2" x 29-1/2"	18-1/4" x 27-1/4"	White	J-Channel
1827BF	19"-1/2" x 28-1/2"	18-1/4" x 27-1/4"	Brown	Flush

## 18x36 Vertical Slider

SKU	Overall Size	Rough Opening	Color	Mount
1836WF	19"-1/2" x 37-1/2"	18-1/4" x 36-1/4"	White	Flush
1836WJ	20"-1/2" x 38-1/2"	18-1/4" x 36-1/4"	White	J-Channel
1836BF	19"-1/2" x 37-1/2"	18-1/4" x 36-1/4"	Brown	Flush

## 21x27 Vertical Slider

SKU	Overall Size	Rough Opening	Color	Mount
2127WF	22"-1/2" x 28-1/2"	21-1/4" x 27-1/4"	White	Flush
2127WJ	23"-1/2" x 29-1/2"	21-1/4" x 27-1/4"	White	J-Channel
2127BF	22"-1/2" x 28-1/2"	21-1/4" x 27-1/4"	Brown	Flush

## 24x27 Vertical Slider

SKU	Overall Size	Rough Opening	Color	Mount
2427WF	25"-1/2" x 28-1/2"	24-1/4" x 27-1/4"	White	Flush
2427WJ	26"-1/2" x 29-1/2"	24-1/4" x 27-1/4"	White	J-Channel
2427BF	25"-1/2" x 28-1/2"	24-1/4" x 27-1/4"	Brown	Flush

## 24x36 Vertical Slider

SKU	Overall Size	Rough Opening	Color	Mount
2436WF	25"-1/2" x 37-1/2"	24-1/4" x 36-1/4"	White	Flush
2436WJ	26"-1/2" x 38-1/2"	24-1/4" x 36-1/4"	White	J-Channel
2436BF	25"-1/2" x 37-1/2"	24-1/4" x 36-1/4"	Brown	Flush

## 30x36 Vertical Slider -Special Order

SKU	Overall Size	Rough Opening	Color	Mount
3036WF	31"-1/2" x 37-1/2"	30-1/4" x 36-1/4"	White	Flush
3036WJ	32"-1/2" x 38-1/2"	30-1/4" x 36-1/4"	White	J-Channel
3036BF	31"-1/2" x 37-1/2"	30-1/4" x 36-1/4"	Brown	Flush

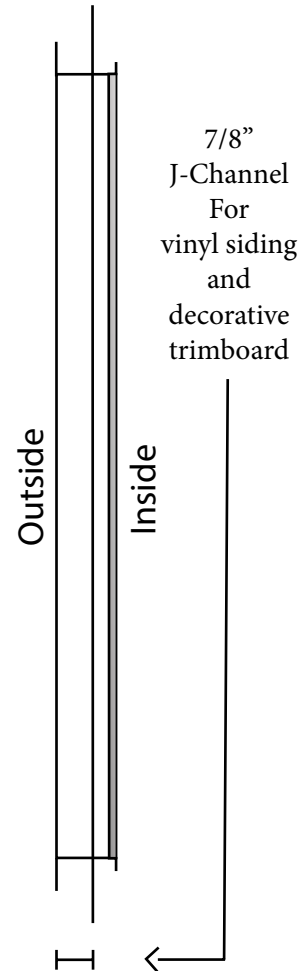

# Arched Windows

## Arched Verticle Sliders

These Arched Verticle Sliders are perfect for any playhouse, tree house, or garden shed. It combines the Sun Burst window with a verticle slider window.

-The arched windows are made with the same quality except the top is arched

-Come standard with 4.7625 mils (3/16") safety/tempered glass  
Increased thickness of frame for added strength

-Notched inner frame to allow for multiple open locking positions, screen included

-Spring loaded latches allow windows to lock in open positions

-There is a 1" screw flange all around the window, the depth of the window is 1-1/2"

-J-Channel is 7/8" and is only available in white

-J-Channel 7/8" is used for vinyl or metal siding. It is also used to slide in trim board. The glass of the window will be flush with the product you insert into the J-Channel

-Weather stripping on sash for weather resistance

-Sloped sill for drainage

-Nylon glides make for an easy open and close operation

-Easy instillation

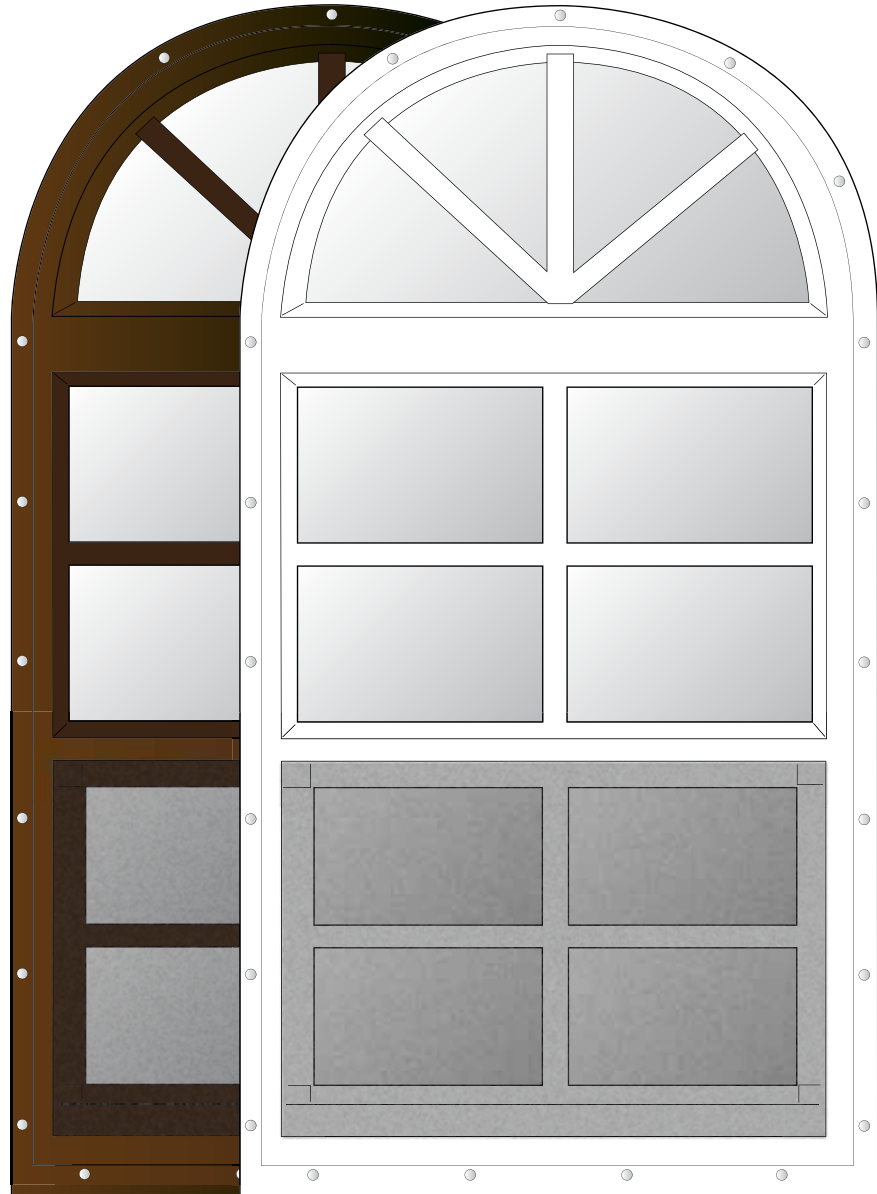

SKU	Size	Overall Size	Rough Opening	Color	Mount
A1428WF	14" x 28"	15"-1/2" x 29-1/2"	14-1/4" x 28-1/4"	White	Flush
A1428WJ	14" x 28"	16"-1/2" x 30-1/2"	14-1/4" x 28-1/4"	White	J-Channel
A1428BF	14" x 28"	15"-1/2" x 29-1/2"	14-1/4" x 28-1/4"	Brown	Flush
A1832WF	18" x 32"	19-1/2" x 33-1/2"	18-1/4" x 32-1/4"	White	Flush
A1832WJ	18" x 32"	20-1/2" x 34-1/2"	18-1/4" x 32-1/4"	White	J-Channel
A1832BF	18" x 32"	19-1/2" x 33-1/2"	18-1/4" x 32-1/4"	Brown	Flush

# Arched Windows

## Arched Transom

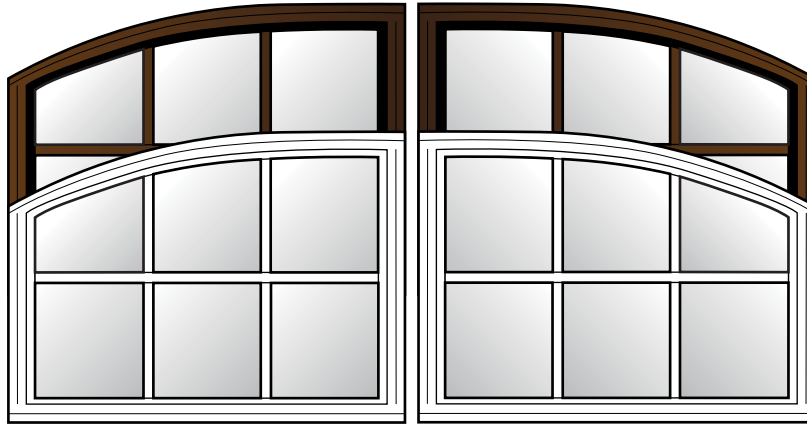

SKU	Size	Overall Size	Rough Opening	Color	Mount
A1523W	15" x 23"	16"-1/2" x 24-1/2"	15-1/4" x 23-1/4"	White	Flush
A1523B	15" x 23"	16"-1/2" x 24-1/2"	15-1/4" x 23-1/4"	Brown	Flush
A1529W	15" x 29"	16"-1/2" x 30-1/2"	15-1/4" x 29-1/4"	White	Flush
A1529B	15" x 29"	16"-1/2" x 30-1/2"	15-1/4" x 29-1/4"	Brown	Flush

## Arched Top Window

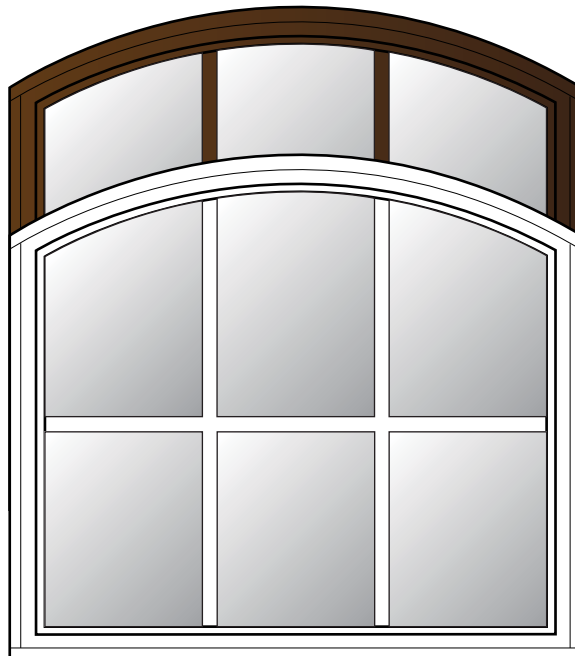

SKU	Size	Overall Size	Rough Opening	Color	Mount
A2825W	28" x 25"	29"-1/2" x 26-1/2"	28-1/4" x 25-1/4"	White	Flush
A2825B	28" x 25"	29"-1/2" x 26-1/2"	28-1/4" x 25-1/4"	Brown	Flush

# MoreView Window

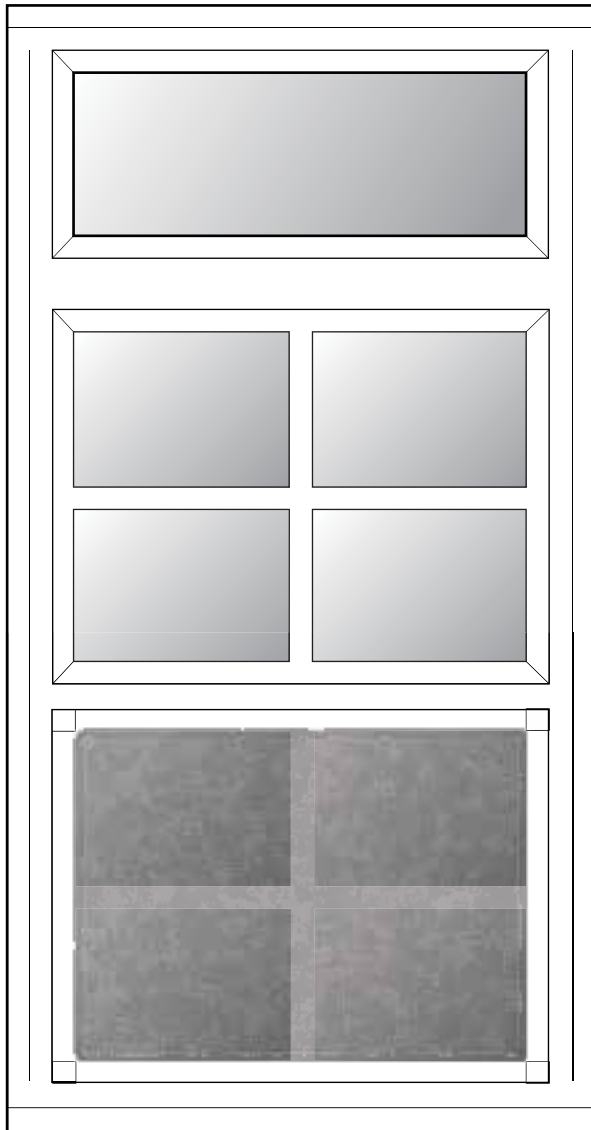

## MoreView Windows

- More View Windows are made of the same quality with an extra view at the top
- Come standard with 4.7625 mils (3/16") safety/tempered glass
- Increased thickness of frame for added strength
- Notched inner frame to allow for multiple open locking positions, screen included
- Spring loaded latches allow windows to lock in open positions
- There is a 1" screw flange all around the window, the depth of the window is 1-1/2"
- J-Channel is 7/8" and is only available in white
- J-Channel 7/8" is used for vinyl or metal siding. It is also used to slide in trim board. The glass of the window will be flush with the product you insert into the J-Channel
- Weather stripping on sash for weather resistance  
Sloped sill for drainage
- Nylon glides make for an easy open and close operation
- Easy installation

SKU	Size	Overall Size	Rough Opening	Color	Mount
MV1224WF	14" x 24"	15-1/2" x 25-1/2"	14-1/4" x 24-1/4"	White	Flush
MV1224WJ	14" x 24"	16-1/2" x 26-1/2"	14-1/4" x 24-1/4"	White	J-Channel
MV1224BF	14" x 24"	15-1/2" x 25-1/2"	14-1/4" x 24-1/4"	Brown	Flush
MV1829WF	18" x 29"	19-1/2" x 30-1/2"	18-1/4" x 29-1/4"	White	Flush
MV1829WJ	18" x 29"	20-1/2" x 31-1/2"	18-1/4" x 29-1/4"	White	J-Channel
MV1829BF	18" x 29"	19-1/2" x 31-1/2"	18-1/4" x 29-1/4"	Brown	Flush
MV2434WF	24" x 34"	25-1/2" x 35-1/2"	24-1/4" x 34-1/4"	White	Flush
MV2434WJ	24" x 34"	26-1/2" x 36-1/2"	24-1/4" x 34-1/4"	White	J-Channel
MV2434BF	24" x 34"	25-1/2" x 35-1/2"	24-1/4" x 34-1/4"	Brown	Flush



# DuraView Window

## DuraView Windows

-Built of strong aluminum box beam frame with glazed Paragon Marine Grade SuperClear PVC film

-Paragon SuperClear PVC film glazing is specifically designed for outdoor buildings and marine environments

-The film has a thickness of .25mm (10gauge) and is rated at 1000 hours UV resistant

-It is cold crack resistant up to -25 degrees

-Spring and pin sashes in durable aluminum that easily glide up and down and hold at any position along the window jamb

-Sashes are easily tilted in for cleaning or removable for storage. Full screen



<b>SKU</b>	DV1421W
<b>Size</b>	14" x 21"
<b>Overall Size</b>	16-1/16" x 22-13/16"
<b>Rough Opening</b>	14-1/4" x 21-1/8"
<b>Color</b>	White
<b>Mount</b>	Flush

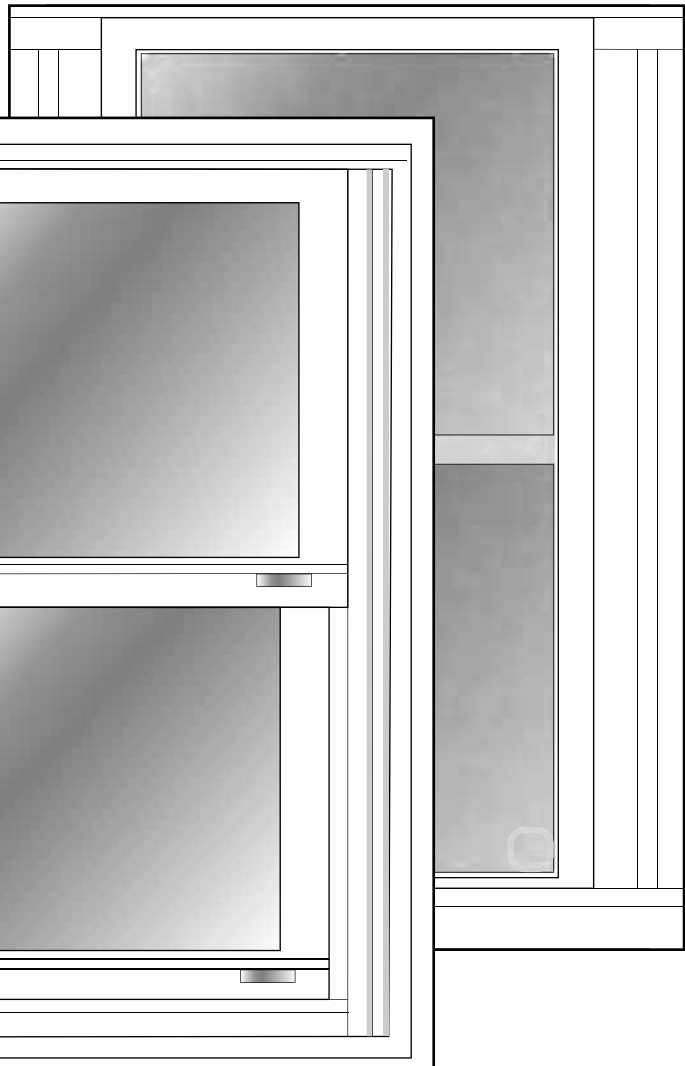

Found Only at  
Shed Windows and More, Inc.

# Decorative Gabel Windows

## Round Windows

SKU	Overall Size	Rough Opening	Color	Mount
10ROUNDB	11"-1/2"	10"	Brown	Flush
10ROUNDW	11"-1/2"	10"	White	Flush
16ROUNDB	17"-1/2"	16"	Brown	Flush
16ROUNDW	17"-1/2"	16"	White	Flush

## 14" & 18" Octagon Windows

SKU	Overall Size	Rough Opening	Color	Mount
OCT14WF	15"-1/2" x 15"-1/2"	14-1/4" x 14-1/4"	White	Flush
OCT14WJ	16"-1/2" x 16"-1/2"	14-1/4" x 14-1/4"	White	J-Channel
OCT14BF	15"-1/2" x 15"-1/2"	14-1/4" x 14-1/4"	Brown	Flush
OCT18WF	19"-1/2" x 19"-1/2"	18-1/4" x 18-1/4"	White	Flush
OCT18WJ	20"-1/2" x 20"-1/2"	18-1/4" x 18-1/4"	White	J-Channel
OCT18BF	19"-1/2" x 19"-1/2"	18-1/4" x 18-1/4"	Brown	Flush

## 10" & 16" Round Window

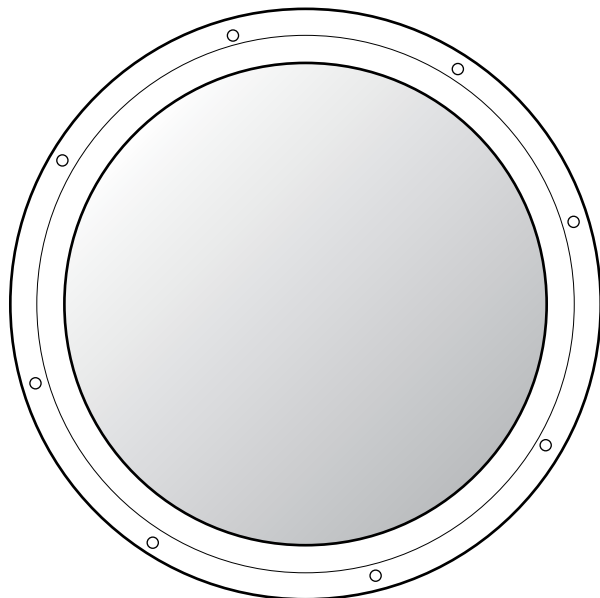

## 18" Octagon Window

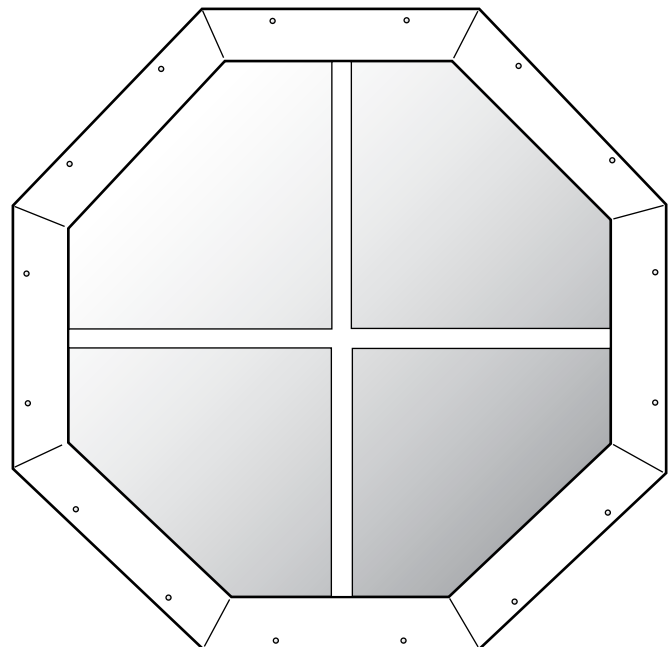

# Decorative Gabel Windows

## 12x12 Windows

SKU	Overall Size	Rough Opening	Color	Mount
1212WF	13"-1/2" x 13-1/2"	12-1/4" x 12-1/4"	White	Flush
1212WJ	14"-1/2" x 14-1/2"	12-1/4" x 12-1/4"	White	J-Channel
1212BF	13"-1/2" x 13-1/2"	12-1/4" x 12-1/4"	Brown	Flush
1212BJ	14"-1/2" x 14-1/2"	12-1/4" x 12-1/4"	Brown	J-Channel

## 16x16 Windows

SKU	Overall Size	Rough Opening	Color	Mount
1616WF	17"-1/2" x 17-1/2"	16-1/4" x 16-1/4"	White	Flush
1616WJ	18"-1/2" x 18-1/2"	16-1/4" x 16-1/4"	White	J-Channel
1616BF	17"-1/2" x 17-1/2"	16-1/4" x 16-1/4"	Brown	Flush

## 18x18 Windows

SKU	Overall Size	Rough Opening	Color	Mount
1818WF	19"-1/2" x 19-1/2"	18-1/4" x 18-1/4"	White	Flush
1818WJ	20"-1/2" x 20-1/2"	18-1/4" x 18-1/4"	White	J-Channel
1818BF	19"-1/2" x 19-1/2"	18-1/4" x 18-1/4"	Brown	Flush

## Square Decorative Windows

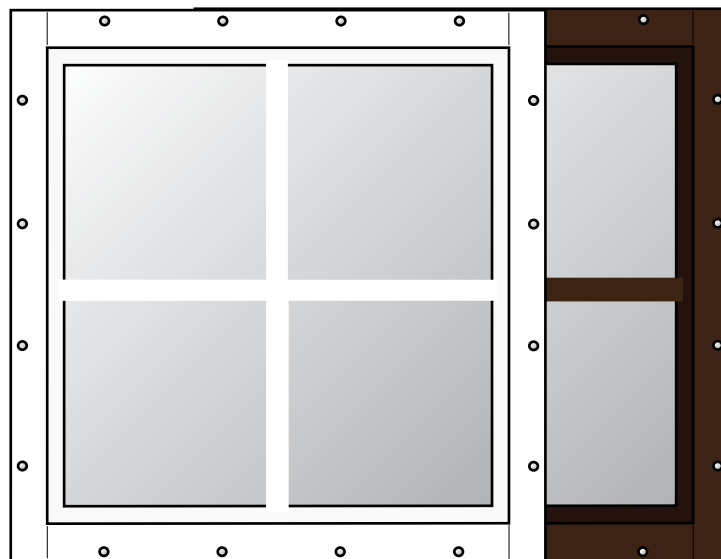

# Transoms

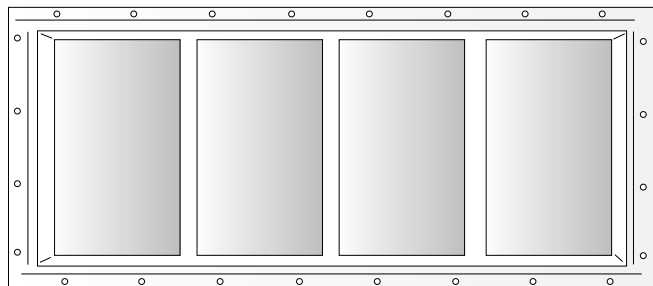

- All transom windows come standard with the same 4.7625 mils (3/16") safety/tempered glass
- Has an all-aluminum frame that comes in white or brown
- J-Channel 7-8" is used for vinyl or metal siding, also used for decorative trim board
- Available in: White Flush, White J-Channel, and Brown Flush
- Easy installation

SKU	Size	Overall Size	Rough Opening	Color	Mount
TR1018WF	10" x 18"	11"-1/2" x 19-1/2"	10-1/4" x 18-1/4"	White	Flush
TR1018WJ	10" x 18"	12"-1/2" x 20-1/2"	10-1/4" x 18-1/4"	White	J-Channel
TR1018BF	10" x 18"	11"-1/2" x 19-1/2"	10-1/4" x 18-1/4"	Brown	Flush
TR1023WF	10" x 23"	11"-1/2" x 24-1/2"	10-1/4" x 23-1/4"	White	Flush
TR1023WJ	10" x 23"	11"-1/2" x 25-1/2"	10-1/4" x 23-1/4"	White	J-Channel
TR1023BF	10" x 23"	11"-1/2" x 24-1/2"	10-1/4" x 23-1/4"	Brown	Flush
TR1024WF	10" x 24"	11"-1/2" x 25-1/2"	10-1/4" x 24-1/4"	White	Flush
TR1029WF	10" x 29"	11"-1/2" x 30-1/2"	10-1/4" x 29-1/4"	White	Flush
TR1029WJ	10" x 29"	11"-1/2" x 30-1/2"	10-1/4" x 29-1/4"	White	J-Channel
TR1029BF	10" x 29"	11"-1/2" x 30-1/2"	10-1/4" x 29-1/4"	Brown	Flush
TR1030WF	10" x 30"	11"-1/2" x 31-1/2"	10-1/4" x 30-1/4"	White	Flush
TR1035WF	10" x 35"	11"-1/2" x 36-1/2"	10-1/4" x 35-1/4"	White	Flush
TR1035WJ	10" x 35"	11"-1/2" x 37-1/2"	10-1/4" x 35-1/4"	White	J-Channel
TR1035BF	10" x 35"	11"-1/2" x 36-1/2"	10-1/4" x 35-1/4"	Brown	Flush
TR1060WF	10" x 60"	11"-1/2" x 61-1/2"	10-1/4" x 60-1/4"	White	Flush
TR1060WJ	10" x 60"	11"-1/2" x 62-1/2"	10-1/4" x 60-1/4"	White	J-Channel
TR1060BF	10" x 60"	11"-1/2" x 61-1/2"	10-1/4" x 60-1/4"	Brown	Flush
TR1072WF	10" x 72"	11"-1/2" x 73-1/2"	10-1/4" x 72-1/4"	White	Flush
TR1072WJ	10" x 72"	12"-1/2" x 74-1/2"	10-1/4" x 72-1/4"	White	J-Channel

# Handles

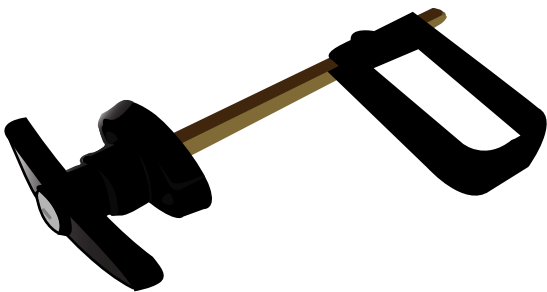

**T-Handle - Black/Chrome**

Your Door Thickness	T-Handle Sizes
Up to 2-1/2"	3-1/2"
Up to 3-1/2"	4-1/2"
Up to 4-1/2"	5-1/2"
Up to 5-1/2"	6-1/2"

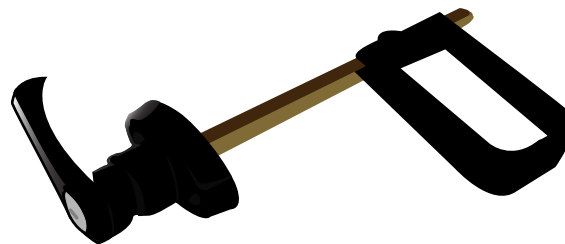

**L-Handle - Black/Chrome**

Your Door Thickness	L-Handle Sizes
3-1/2"	4-1/2"
4-1/2"	5-1/2"

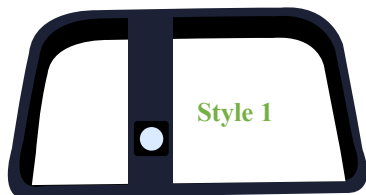

**D-Back**

Style
Cross Bar - Style 1
No Cross Bar - Style 2

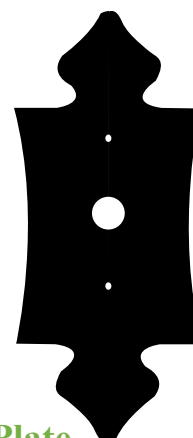

**Handle Back Plate**

Height	Width
5-3/8"	2"



**Keys - 201, 573, 621**

# Door Hardware

---



**Barn Pull**



**Barrel Bolts**



**Heavy Duty Barrel Bolts**



**Bumpers- White/Black**



**Cane Bolt - 18"**



**Chain Bolt**



**Door Brace 42" or 50"**



**Drop Latch**



**Hasp**

# Hinges

## Hinge Info.

All of our hinges are solid steel construction. All hinges come with nylon washers except 4" standard hinge.. All of the hinge pins are capped for non-removal and security. Hinges are powder coated in black.

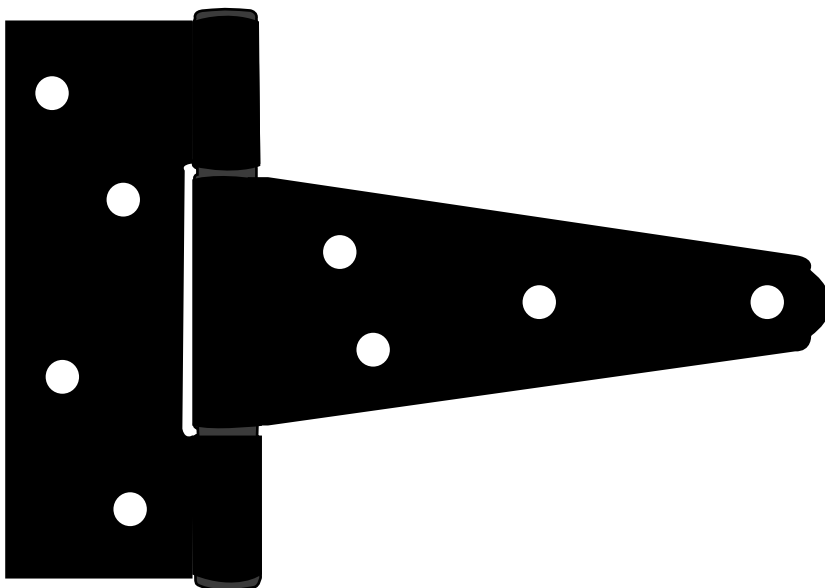

## Standard Heavy Duty T-Hinge

SKU	Size	Hinge Plate Size	Hinge Strap Length	Hinge Strap Height
H4B	4"	3-3/8" x 1-1/8"	4-1/8"	1-5/8"
H5B	5"	3-13/16" x 1-1/4"	5-1/8"	1-7/8"
H6B	6"	4-3/8" x 1-9/16"	6"	2-1/4"
H8B	8"	5-1/2" x 2-1/16"	8-3/16"	2-5/8"
H10B	10"	7-3/4" x 3-3/4"	10-3/8"	3-5/8"

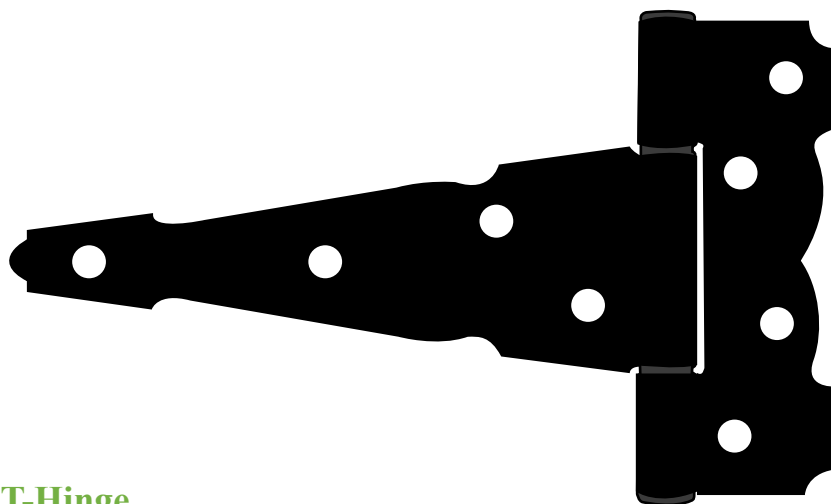

## Colonial Style T-Hinge

SKU	Size	Hinge Plate Size	Hinge Strap Length	Hinge Strap Height
H4B	4"	3-3/16" x 1-5/8"	4"	1-1/2"
H5B	5"	3-15/16" x 1-1/2"	4-7/8"	1-7/8"
H6B	6"	4-1/4" x 1-3/4"	6"	2"
H8B	8"	5-1/2" x 2-5/16"	8"	3"

# Hinges

## 72" Continuous Barn Hinge

All Aluminum construction with aluminum pin open flat 2" x .060 thick 1/2" knuckle, 1/8" pin holes every 2" hinge takes 72 screws #8

## 20" Super Heavy Duty Hinge

Hinge Plate Size	Hinge Strap Length	Hinge Strap Height
10" x 2-1/8"	20-1/2"	2"

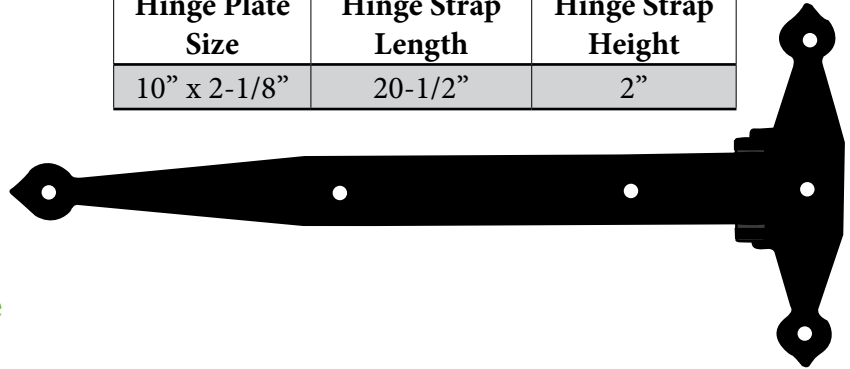

## 12" Gate Hinge



Hinge Plate Size	Hinge Strap Length	Hinge Strap Height
8" x 1-1/8"	12-1/8"	1-1/2"

## 12" Decorative Hinge



Hinge Plate Size	Hinge Strap Length	Hinge Strap Height
8" x 1-1/8"	12-1/8"	1-1/2"

## 12" Dutch Style Hinge



Hinge Plate Size	Hinge Strap Length	Hinge Strap Height
10" x 1-1/8"	12-1/8"	1-1/2"



# Hinges

## 13" Decorative Hammered or Smooth Finish Hinge



Hinge Plate Size	Hinge Strap Length	Hinge Strap Height
2-7/8" x 1-1/8"	13-1/2"	1-3/8"

## 3-1/2" Barn Hinge

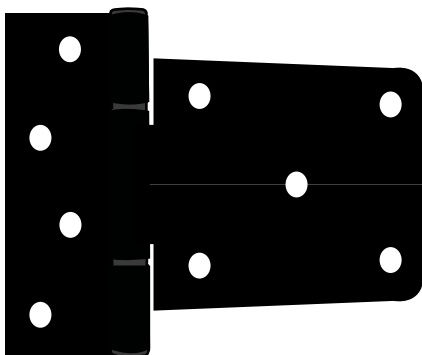

Hinge Plate Size	Hinge Strap Length	Hinge Strap Height
4-7/16" x 1-1/8"	3-11/16"	3-5/16"

## 3-1/2" Butt Hinge

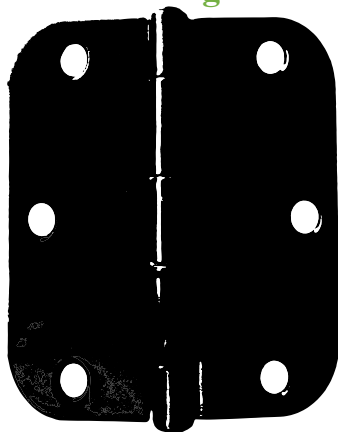

Hinge Plate Size	Hinge Pin to Edge	Hinge Overall
3-1/2" x 1-3/4"	1-3/4"	3-1/2" x 3-1/2"

## 3" Butt Hinge

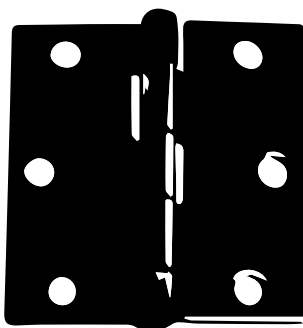

Hinge Plate Size	Hinge Pin to Edge	Hinge Overall
3" x 1-1/2"	1-1/2"	3" x 3"

# Hardware Kit

## Hardware Kit # 1



## Product Info.

Custom Hardware Kits

Comes with:

- 6 Hinges of your choice
- 2 (1 Pair) Barrel Bolts of your choice
- 1 T-Handle of your choice
- 1 bag of 52 screws of your choice

Customize your hardware kit your way!

Everything you need for a double shed door in one kit

Hinge Style	Hinge Size
Standard	5", 6", 8", 10"
Colonial	5", 6", 8"
Decorative	12"
Gate	12"
Colonial Strap (Hammered or Smooth)	13"
Super Heavy Duty	12", 17", 20"

Door Thickness	T-Handle Size
2-1/2"	3-1/2"
3-1/2"	4-1/2"
4-1/2"	5-1/2"
5-1/2"	6-1/2"

Screw Size	Barrel Bolt Type
1-1/2"	Loop Style
1-3/4"*	Heavy Duty*
2"*	--
2-1/2" *	--

\* There is a upcharge when choosing these items

# Screws & Vents



## Black Screws

Our Screws are all #2 Suarea Drive Screws. Designed with a Bugle Head which lies flat flush to the surface. Built with a heavier gauge body, provides more material for long drilling with less chance of twist off. Two thirds threading eliminates gap caused by thrust. Deep Threads for better grip, especially useful in wood composite materials.

<b>Sizes:</b>	1"	1-1/4"	1-1/2"	1-3/4"	2"	2-1/2"
---------------	----	--------	--------	--------	----	--------

Comes in Packs of 50, 100, 500, & 1000

## 12" x 18" PVC Arched "Classic" Gable Vent

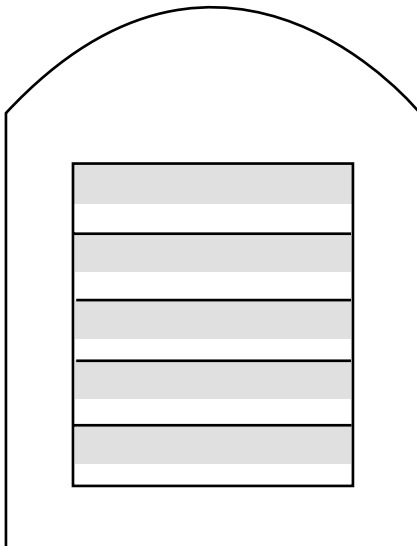

## PVC Gable Vent

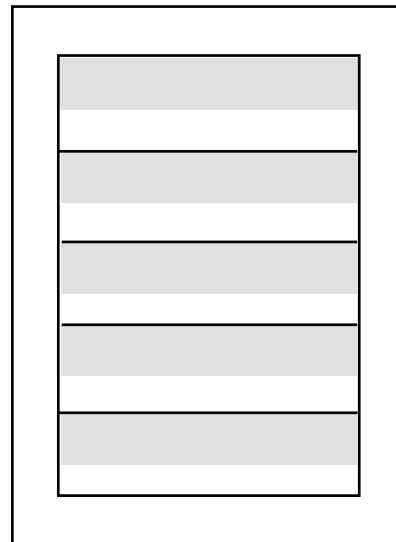

<b>Sizes:</b>
8" x 8"
8" x 12"
12" x 12"

## 6" Round PVC Gable Vent

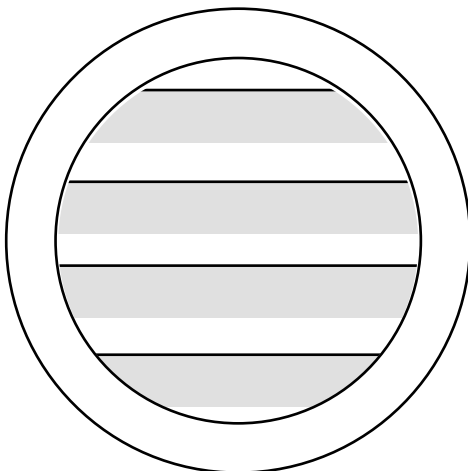

## Exhaust Vent

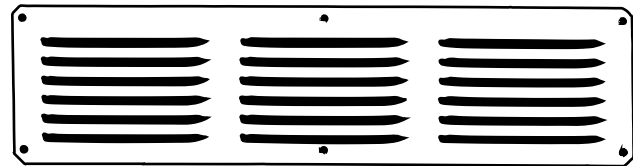

These Exhaust Vent are made of Aluminum and come with a mesh screen on the back to keep bugs out.

Size	Color
4" x 16"	White or Brown
8" x 16"	White or Brown

# Skylights

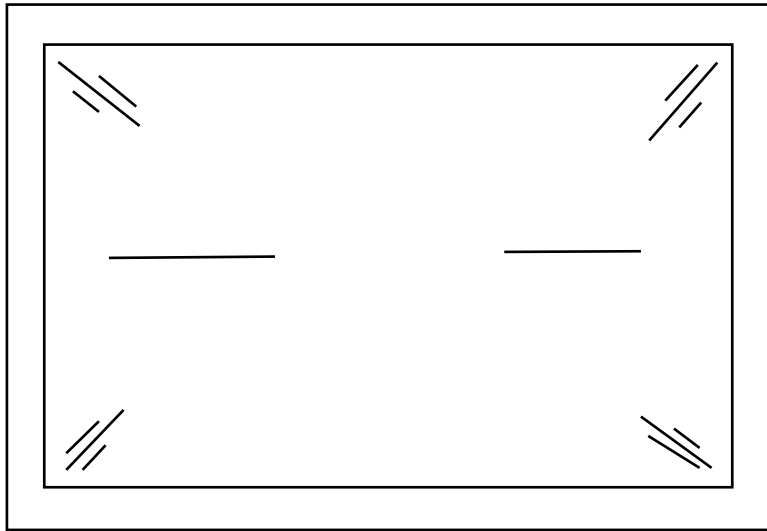

## Sizes: Roof Opening

- 14-1/2" x 14-1/2"
- 14-1/2" x 22-1/2"
- 14-1/2" x 30-1/2"
- 22-1/2" x 22-1/2"

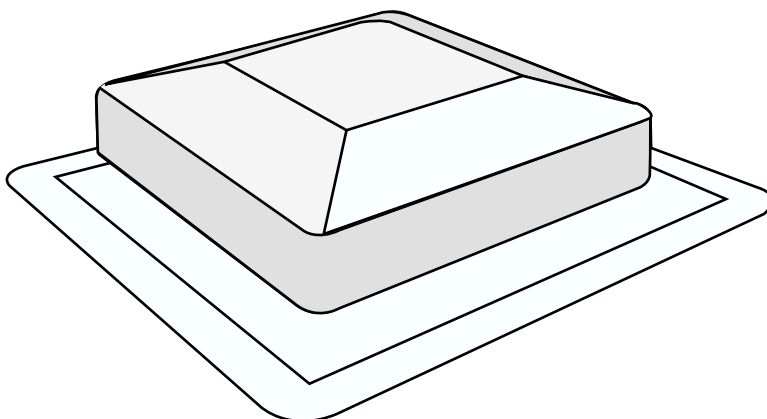
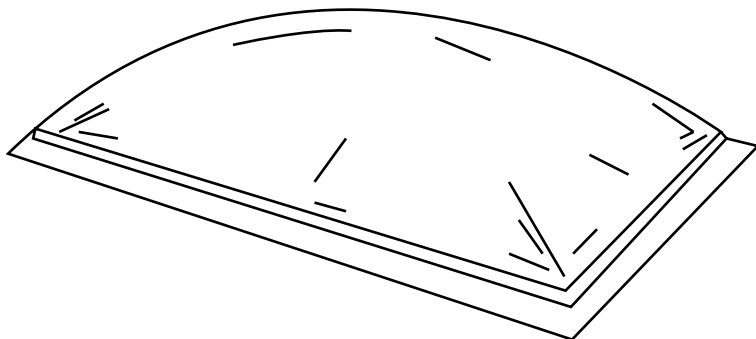

## Dome Skylights

Dome Skylights come completely assembled ready to install. Pre drilled holes make for easy install.

- Minimum pitch 3:12
- Use on asphalt shingles roofs only

Comes in **Single** or **Double Layer** Polycarbonate.

Double Polycarbonate is used for insulating to be more energy efficient

Tinted Bronze

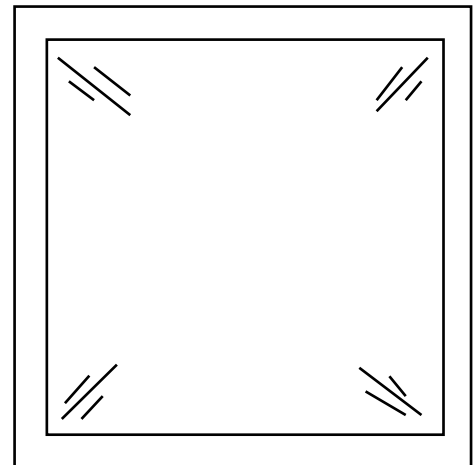

## Skylight Roof Vent

Translucent PVC Skylight Roof Vent allows more natural light in and exhaust the hot air.

## Sizes

- 50 Sq Inch
- 75 Sq Inch

# Miscellaneous Products



**Glider Arms (Yellow Zinc & Stainless Steel)**

**Glider Bearings**

Glider Arm Sizes
7-1/2" Center hole to center hole
6-1/2" Center hole to center hole

Glider Bearings Yellow Zinc
3/8"
1/2"
5/16"
Glider Bearings Stainless Steel
5/16"

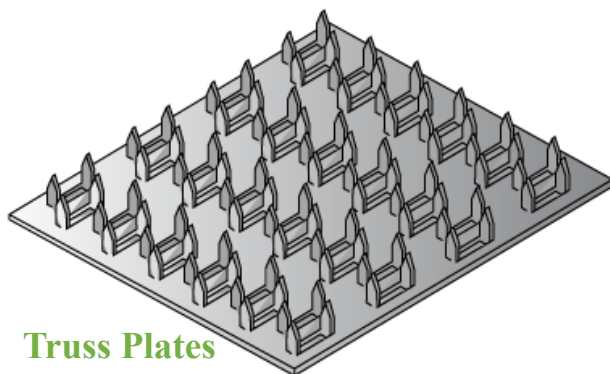

**Truss Plates**

Truss Plate Sizes
4" x 4"
4" x 6"
3" x 3"
3" x 4"
3" x 5"



**Shutter Dogs - S Hold Backs**



**Stem Rocker Bearings**

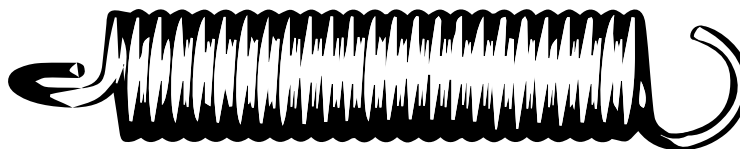

**Heavy Duty Spring**



 **Shed Windows and More** ®

(843) 293-1820

[shedwindowsandmore.com](http://shedwindowsandmore.com)